

End View

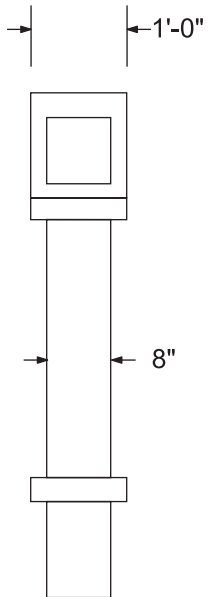

Front and Back View

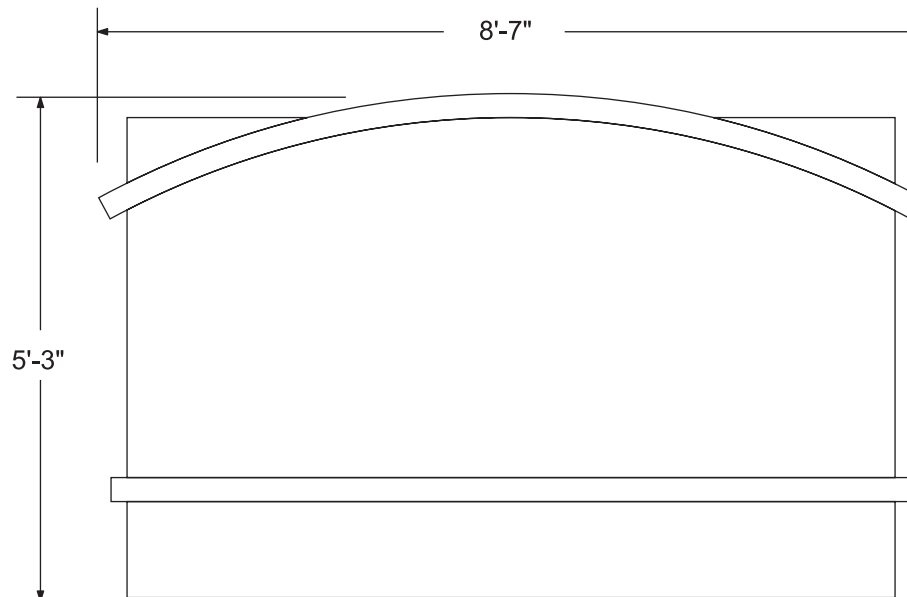

*Peachtree City*  
**Foamcraft**  
ARCHITECTURAL ACCENTS & SIGN STRUCTURES  
386 Senoia Rd., Tyrone, GA 30290 Ph: 770-487-5491 Fax: 770-487-5408

Standard Model #36  
Size: 5' 3" x 8' 7"  
Overall Sq/Ft: 45.1  
Date: 5/19/2003  
Scale: 1/2" = 12"

Notes:  
\_\_\_\_\_  
\_\_\_\_\_  
\_\_\_\_\_  
\_\_\_\_\_

**Copyright Notice ©**  
This drawing and all reproductions thereof are the property of **Peachtree City Foamcraft** and may not be reproduced, published, changed or used in any way without written consent.