

End View

Front and Back View

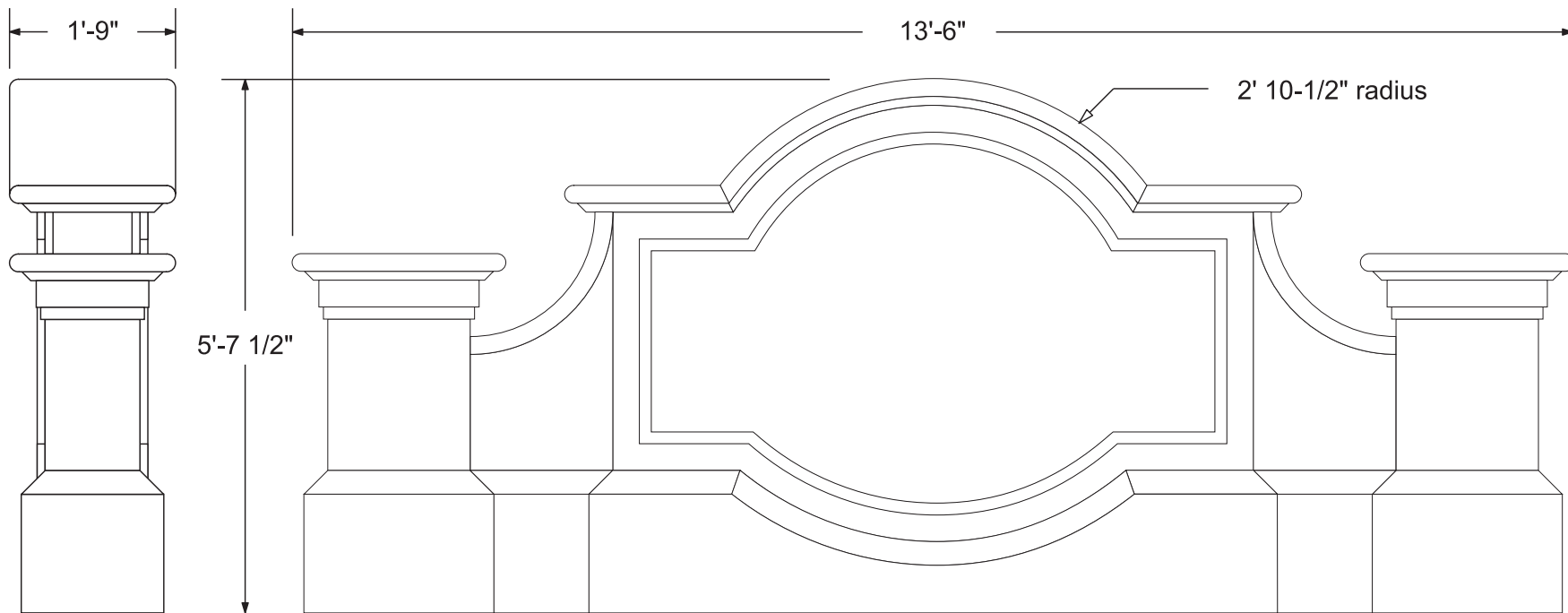

Peachtree City
Foamcraft
ARCHITECTURAL ACCENTS & SIGN STRUCTURES

386 Senoia Rd., Tyrone, GA 30290 Ph: 770-487-5491 Fax: 770-487-5408

Standard Model #26
Size: 5' 7-1/2" x 13'6"
Overall Sq/Ft: 76
Date: 5/19/2003
Scale: 1/2" = 12"

Notes:

Copyright Notice ©

This drawing and all reproductions thereof are the property of **Peachtree City Foamcraft** and may not be reproduced, published, changed or used in any way without written consent.